

KANMED^o WARMINGCABINET

USER MANUAL AND TECHNICAL MANUAL

Kanmed Universal Warming Cabinets
Kanmed Blanket Warming Cabinets
Kanmed Combination Cabinet
Kanmed Table Top Cabinet

GE-2300-070 VERSION 9
2024-02-09



NOTE:

This manual contains important information concerning safety and daily use as well as maintenance and service instructions and should be kept for future use.



Manufactured by:
KANMED AB
Hammarbacken 6A
191 49 Sollentuna
Sweden

This manual is valid for all Warming Cabinets with Art No GE-2xxx and the new regulator introduced September 2018



NOTE:

The preset maximum temperature in the **Universal Cabinets** and the **Table Top Cabinet GE-2442** is 42°C.

The pre-set maximum temperature in the **Blanket Warming Cabinets** is 70°C and in the Table Top Cabinet, GE-2470, is the maximum temperature 60°C.

The pre-set maximum temperature in the Combination Cabinet is 42°C in the Fluid compartment and 70°C in the Blanket compartment.

However, your Cabinet may have been ordered with another maximum temperature or may have been changed by your own technician.

Press SET and ▲ to see the maximum selectable temperature.

Make sure that the contents in the Cabinet can withstand this temperature.

Large Cabinets on Feet: You must secure the Cabinet to the wall using the built-in brackets at the top of the Cabinet.

TABLE OF CONTENTS

TABLE OF CONTENTS	2
1. SAFETY INSTRUCTIONS	3
2. GENERAL DESCRIPTION	4
3. DESCRIPTION OF FUNCTION	5
4. INSTALLATION	5
5. USING THE CABINET	5
6. REGULAR MAINTENANCE	6
7. TECHNICAL SECTION	6
8. TECHNICAL DATA	9
9. ACCESSORIES AND SPARE PARTS	11
10. CIRCUIT DIAGRAM FOR CABINETS WITH ART. NO. GE-2XXX	14
11. WARRANTY	17
12. EMC COMPATIBILITY STATEMENT	17
13. END OF LIFE	17

UNPACKING AND PACKING LIST

When the Cabinet is shipped from Kanmed it is carefully packed. Check for damages on the packing material and make sure the truck driver notes any damages on the delivery note.

Check for damages and report them immediately to your supplier. Damages reported after the Cabinet has been used will not be accepted.

Follow the unpacking instructions that are enclosed in the packaging when installing the cabinet.

1. SAFETY INSTRUCTIONS

INTENDED USE

The Kanmed Warming Cabinet models GE-2xxxx are intended for warming of gel pads, blankets, fluids, surgical instruments and similar, to reduce patient hypothermia and to increase patient comfort. It shall be used indoors in a professional medical environment by healthcare staff and in accordance with the user manual and the institutions protocols.













Kanmed Warming Cabinets are NOT intended for warming of Blood Products, human tissue and Nutritional Products.

IMPORTANT SAFETY ADVICE

- Adjust the Cabinet so that it is correctly positioned, vertically and horizontally.
 - **Large Cabinet on Feet: You must secure the Cabinet to the wall using the built-in brackets at the top of the Cabinet.**
Note! If the Cabinet, **at your own risk**, is not secured to a wall, don't pull out more than one shelf/basket at a time.
 - Cabinets on wheels are not intended for transport of hospital products. The intention of the wheels is to facilitate moving the Cabinet for easy cleaning under and behind the Cabinet. When moving the Cabinet make sure the wheels do not hit any obstacles. Roll the Cabinet with its front in the direction of where you want to go.
 - Cabinets on wheels must be rolled slowly and with great care.
 - Never pull out all shelves/baskets at the same time. The Cabinet can tilt forward if it is not properly secured to the wall.
 - Do not overload the shelves/baskets.
 - Maximum load on a shelf is 20 kg.
 - Maximum load in a basket is 20kg.
 - Do not overfill the top shelf - there must be at least 5 cm free space to ensure air circulation.
 - Avoid blocking the ventilation holes inside of the Cabinet.
 - Ensure that the contents can withstand the temperature you have selected otherwise you may risk destroying the contents and burn the patients.
 - Risk of burning patient. If your Cabinet temperature is set higher than 42°C you must check that the contents are not too warm when they reach the patient.
 - Risk of burning yourself. If your Cabinet is set higher than 42°C you must be careful when you touch contents and the inner surfaces of the Cabinet.
 - Do not warm Blood Products, human tissue, and Nutritional Products in the Cabinet.
-
- The wheels shall be mounted as per the picture below.



EXPLANATION OF SYMBOLS

<p>Combination Cabinet only. The Blanket compartment may be very hot:</p>	
<p> On Off button on display. Not activated</p>	<p>~ AC current</p>
<p> UP button rises temperature</p>	<p> DOWN button decreases temperature</p>
<p> SET button, for displaying and changing desired temperature</p>	
	<p>Manufacturer</p>
	<p>Date of manufacture</p>
	<p>Article number</p>
	<p>Serial number</p>
	<p>Weight complete unit (example only)</p>
	<p>Fulfils EU 2017/745 (MDR) and 2011/65/EU (RoHS).</p>
	<p>Indicates that the item is a medical device.</p>

2. GENERAL DESCRIPTION

THE CABINET

The Cabinet is made of stainless steel and is very well insulated to reduce heat loss to environment and noise. For the same reason, the door is double glassed with safety glass (breaks into thousands of small pieces if broken). (Single glass in the Table Top Cabinet)

THE HEATING COMPARTMENT

The heating element, fan, thermostat T2 and temperature sensors are all mounted on a "pull out shelf" inside the top of the Cabinet. The heating compartment is kept in place by a small screw that, when loosened, allows the whole heating compartment to be pulled completely out. This makes service quick and easy. In the Table Top Cabinet **all** components are accessible by loosening the top cover.

THE ELECTRONICS COMPARTMENT

The electronics compartment is located on the top of the Cabinet. The power cable is connected at the back of the electronic compartment.

THE SHELVES-BASKETS

The shelves/baskets run on wheels and can be pulled fully out until they automatically stop. To completely remove the shelves/basket for cleaning or repositioning, lift the front upwards and remove it. The shelves in the Table Top Cabinet are on slides.

EXTRA SHELVES- EXTRA BASKETS

Extra shelves/baskets and rails are available.

Push the shelf/basket in place by holding the front higher than the rear.

Shelves in the Blanket Warming Cabinet are hung using the holes in the side walls and make sure that all shelf tabs are engaged in the holes in the side wall.

3. Description of function

The Warming Cabinet and its contents are warmed by circulating warm air which is heated by an electric heating element. The warm air is circulated by a fan and distributed evenly through the outlets. The temperature is regulated, by the temperature regulator T1 to the set temperature.

Thermostat T2 functions as over temperature protection and will take over the temperature control in case the air temperature exceeds set maximum temperature by 5°C. At the same time, the red lamp on the front panel will be lit to indicate that there is a malfunction. Inside the heating element itself, there is an additional over temperature protection that is self-resetting. It will be activated in case the fan stops or goes too slow.

The ON/OFF switch isolates the Cabinet electronics from mains power.

NOTE: If the red over temperature lamp is lit there is an error that requires a technician.

4. INSTALLATION

Adjust the feet so that the Cabinet is levelled.

Connect the Cabinet to an earthed power outlet.

NOTE: Always secure a Cabinet with feet to a wall by using the built-in top brackets to avoid the risk of tipping forward.

5. USING THE CABINET

5.1 GENERAL ADVICE

Switch on the Cabinet with the green power switch(es) at the upper front panel. Check the set temperature and adjust if necessary according to 5.2

5.2 TEMPERATURE ADJUSTMENT AND INDICATION

The display shows the actual working temperature in the Cabinet in °C if the ON/OFF switch is on and the door is closed.

The set temperature is indicated when the set button is pressed.

The last set temperature is stored in the controller. The working temperature can be selected in steps of 1°C within the range preset at the factory or by your technician.

The Universal Cabinet is normally set to 42°C. The Blanket Warming Cabinet is usually set to 70°C Table Top cabinet GE-2470, max temp 60°C.

The setting is normally soft blocked meaning that you must first press SET for a few seconds to be able to change the temperature. If you want to change the maximum temperature, then ask a technician for help.

TEMPERATURE REGULATOR

Part number 700-0885, 230VAC version. (700-0886 12/24VDC version.

NOTE: Is sold as spare part for older cabinets with 12VDC transformer)



- SET** Press set button until **UnL** (Un lock) is shown in the display. Press set button once again and use the down/up arrow to select your desired temperature
- UP** Press SET. Press UP arrow within 2 sec. to increase the temperature until the desired value is shown in the display
- Down** Press SET. Press DOWN arrow within 2sec. for a temperature decrease until desired value is shown in the display.
- SET** Press set button when selected temperature is set (to display the actual temp) or just wait a couple of seconds and it goes back automatically
-  On Off button
Is not activated.

6. REGULAR MAINTENANCE

CLEANING

All parts that are to be cleaned are made of stainless steel or glass. Use soap and water for cleaning. For disinfection, use your normal surface disinfection routines detergents, as per your hospital protocol.

7. TECHNICAL SECTION

ANNUAL CHECKS

To be performed yearly by a qualified technician only.

Power Cable: Check the integrity of the power cable and verify proper earth connection. Perform an electrical safety test.

Fan compartment: Check the fan compartment for dust collection and clean if necessary.

Fan: Check that the fan makes no unusual noise.

Labels: Check that all labels are readable. If not, order new labels.

Shelves: Check that they move without effort and noise

Door. Check that it closes properly.

Wheels: Check that they roll without effort and noise and that all bolts are properly tightened and that the brakes function.

Feet: Check that they are intact and straight.

Wall mount bracket: Check that the cabinet is properly secured to the wall.

Glass door: Cracked glass must be exchanged.

Temperatures: Check temperatures annually as per sections below.

7.1 TEMPERATURE CONTROL/CALIBRATION INFORMATION ABOUT TEMPERATURE MEASUREMENT AND CALIBRATION

The working temperature is regulated by the temperature regulator T1 and the over temperature protection by capillary thermostat T2. When checking the calibration of T1 and T2, their value shall be compared to the value of precision thermometer with an air sensor. The sensor T2 can be adjusted through a hole in the bottom of the heating compartment.

Place the sensor of the precision thermometer in the middle of the Cabinet. Allow at least 2 hours for proper warming up.





T1 is a powered microprocessor temperature regulator/indicator that has resolution set to 1°C. Changes and adjustment can be done through a series of pushing's on the regulator buttons according to the description below.

PROCEDURE FOR TEMPERATURE CHECK AND RECALIBRATION

Place the external control sensor as described under 7.1 above.















Start the warming and wait until the temperature is stable (at least 2 hours). Compare the external control thermometer with the set temperature and if the deviation is bigger than +/-1°C adjust as follows.

Regulator Part number 700-0885, 230VAC version. (Also 700-0886 12/24VDC version, Spare part for cabinets with 12VDC transformer). All new cabinets since September 2018

1. Press the "SET" button until "UnL" (Un lock) is displayed.
2. Press and hold the "SET" button until "PA" is displayed.
3. Press "SET" button and press the "DOWN" Arrow until "-19" is displayed
4. Press "SET" again the display should now show "SP".
5. To change a parameter, press  or  button till parameter "CA1" is received.
6. Press SET once and within 2 sec on  or  button to enter the noted temperature difference. Press SET again
For example: The display shows 40°C but the external control temperature shows 37°C. The difference is -3°C. To compensate this difference press  button 3 times. Store the new calibrated value by pressing the "SET" button until it goes back to normal screen and showing the actual temperature.
7. Make a new measurement of the temperature and control that T1 shown value compares to that of the external thermometer.

FOR OLDER CABINETS.

Regulator (Part number 700-0821, 12/24Vdc and 700-0863, 230Vac version)





1. Press  and  exactly simultaneously (only one beep may be heard, if you don't succeed-repeat) and keep buttons pressed for 5 sec until the indicator display shows "PA".
2. Press  one time.
3. Press  within 15s until -19 is displayed.
4. Press  one time.
5. Press  and  exactly simultaneously until "SP" (Select Parameter) is displayed
6. To change a parameter, press  or  button till parameter "CA1" is received.
7. Press SET once and within 2 sec on  or  button to enter the noted temperature difference. Press SET again
For example: The display shows 50°C but the external control temperature shows 47°C. The difference is -3°C. To compensate this difference press  button 3 times.
8. Store the new calibrated value by pressing  and  simultaneously (only one beep may be heard, if you don't succeed-repeat) and keep pressed for 5 sec until the indicator display shows the actual temperature.
9. Make a new measurement of the temperature and control that T1 shown value compares to that of the external thermometer.

7.2 OVER TEMPERATURE T2 CALIBRATION AND CHECK

Adjustment of the over temperature capillary sensor T2 (with a screwdriver) is accessible under the fan compartment. The temperature sensor T2 is a capillary thermostat in series with the heating element. In the Kanmed Cabinet its hysteric is 4°C max. When delivered T2 is set to 5°C above the maximum value of T1. The activation of T2 is identified by a clear click sound as well as when the red over temperature lamp is lit

The procedure described below is a simplified method to check and if necessary adjust T2

PROCEDURE

1. Follow the procedure above, step 1-5, depending of type of regulator version, see above.
2. To change a parameter, press  or  button till parameter "r2" is received. Normally set to 42°C or 70°C. Press "set" and change it to 47 and press set again.
3. Exit the program by pressing the up and down buttons  and  until normal view is present (press and hold the "SET" button on 700-0885 and 700-0886).
4. Press Set again and set the temp to 47°C (5 degree higher than the max value programmed)
5. Turn the capillary adjustment screw fully clockwise (+) (you find it through the hole on the underneath of the shelf and let the Cabinet temperature stabilise.
6. When the temperature is stable adjust the over temperature by turning T2's adjustment counter clockwise back to activation (one click sounds), turn again clockwise past the activation point in tiny steps (a new click sounds). You have now set the over temperature to about 47°C.
7. Repeat the procedure 1-3 and set back the maximal selectable temperature to 42°C or any other value you may have decided upon earlier.
8. Check that you don't activate the over temperature indication when running the Cabinet in normal operation (with T1 pre-set to 42°C) If this should happen you have to repeat the procedure and set T2:s activation point a bit higher.

7.3 TROUBLE SHOOTING

If the warming is not starting, check as follows:

- Power Switch on (If power is OK it will show a green light)
- Power in the wall socket? Fuses OK? Display lit?
- Is the fan rotating? It shall start as soon as the power switched is on. If it is not rotating, making a strange noise or rotates slowly it must be changed.
- Check the fan and that the air intake under the heating compartment is not blocked.
- Red lamp lights up now and then. Check the capillary thermostat and the temperature regulating unit.

NOTE:

All checking that involves opening the heating compartment must be done by a qualified technician.

Ensure that the cables to the heating compartment do not get stuck when you close the heating compartment after service actions.

7.4 CHANGING THE MAXIMUM TEMPERATURE, UP OR DOWN.

Follow the procedure described in 7.1.2 and re-adjust T2 so that it is 4-5°C higher than T1.

NOTE: Think carefully about the risks and consequences of setting the max temp limit **higher** than the factory set temperature and about how to make the staff aware that a higher temperature might have been set by someone not authorised to change the temperature.

7.5 ALARMS / SAFETY FUNCTIONS

The cabinets have the following alarm functions:

- 1 A not activated electronic acoustic and visual alarm that will alarm if the temperature is 4C above set value.
- 2 A mechanical capillary thermostat that breaks the electricity to the heating element if the temperature exceeds the pre-set maximum allowed temperature. When activated a red lamp is lit on the front panel.

Please contact Kanmed or your supplier for instructions how to activate the acoustic over temperature alarm

7.6 MODIFICATIONS

Any modifications on the Cabinets will void Kanmed's responsibilities totally and are not allowed without the written consent of Kanmed.

8. TECHNICAL DATA

	Large Cabinets		Small Cabinets		Combination
	Universal	Blanket	Universal	Blanket	Fluid and Blanket
Outside measurements Height / Width / Depth	168cm /66cm/ 64cm Height without wheels or feet		95cm / 66cm / 64cm Height without wheels or feet		Same as Large Cabinet
Inner Volume	≈415 litres	≈415 litres	≈190 litres	≈190 litres	≈160 +≈160 litres
Inside measurements Height / Width / Dept	140 cm/56 cm/53 cm		65 cm/56 cm/53 cm		≈59 cm /56 cm/ 53 cm x 2
Height Feet. Height Wheels	Feet 13 -18 cm. Wheels 16cm. On the large Cabinets the front wheels stick out 10 cm and add 2 x 13 cm to the total width.				
Voltages / Power max / Fuses	230VAC ± 10% / ≈900W (1800W double Cabinet) / T6,10A 250V . 115VAC 60Hz is also available. Please contact Kanmed. As of serial number 4740 the heating element has been replaced with heating element 500W art no 700-0865				
Average power consumption	100 -200W	100 -250W	100 -200W	150-250W	150-250W
Possible number of Basket / Shelves	10	4	5	2	4 in fluid comp. 2 in blanket comp.
Shelf Width x Dept x Height / Weight (GE-41500)	52x50x2 cm / 4 kg	53x49x1,2 cm /2,2 kg	52x50x2 cm / 4kg	153x49x1,2 cm / 2,2 kg	52x50x1,2 cm / 4kg
Basket size Weight (GE-41600)	52 x 50 x 10 cm 6kg	Only shelves	52x50x10 cm 6 kg	Only shelves	52x50X10 cm / 6kg
Weight without shelves / baskets	≈130 kg	≈130 kg	≈100 kg	≈100 kg	≈140 kg
Doors with magnetic handle	Doors can be hung left or right. Factory standard is left hung. Please specify when ordering. Right hung will increase the delivery time with about 3 weeks.				
Load per shelf/basket	Maximum 20kg				
Warming Capacity	Warms 10 pieces Kanmed Gel GE-455015 from 22°C to 40°C in less than 3 hours.				
Temperature range	35°C to 50°C	35°C to 80°C	35°C to 50°C	35°C to 80°C	36°C to 50°C 36°C to 80°C
Accuracy	± 2°C	± 4°C	± 2°C	± 4°C	±2°C and ±4°C
Factory set maximum temperature	42°C	70°C	42°C	70°C	42°C and 70°C
Other features, information	Made of high quality stainless steel. Polyurethane foam insulation for minimal heat leakage and optimal sound insulation. The Door has double energy saving safety glass. Large and Small Universal Cabinets are equipped with rails for 10/5 shelves or baskets. Hight between the shelves and baskets in the Universal Cabinet is ≈13cm. In the Blanket Warming Cabinets the shelves can be moved up or down in steps of 13 cm.				
Temperature regulation	Programmable electronic temperature regulator with display. Temperature can be blocked at a fixed value. A capillary thermostat ensures independent overtemperature prevention. A bimetal thermostat is integrated in the heating element.				
Other Kanmed warming products	For anaesthesia. Kanmed Operatherm with Gel Pads and Kanmed WarmCloud. For neonatal use. Kanmed BabyWarmer and Kanmed BabyBed				
Noise level	< 50dB				
CE - marking	According to EU 2017/745 (MDR) and 2011/65/EU (RoHS).				
Storage and transport	-20°C to + 40°C				
Type of operation	Continuous				
Expected Lifetime	Kanmed warrants a safe lifetime of 10 years from first day of use. This is under the condition that the Cabinet has been serviced according to the user and or service manual and that the unit has not been modified or changed in any way or for any reason				

Table Top Cabinet		GE-2442, GE-2470	
	Outside measurement: D 52, W 51, H 62 cm		
	Inside measurement: D 47, W 43.5, H 47 cm		
	Inside volume: about 96 litres		
	Weight: 35Kg		
	Voltage: 230VAC ±10%. Max power 400W. Average empty about 50W		
	Stainless steel. Safety glass in door. Rubber feet		
	Stackable 2 and 2		
	Shelves on glides.		
	Left hung door. Can easily be changed to right hung		
Temperature regulation	Programmable electronic temperature regulator with display. Max temperature can be blocked at a fixed value. Same as for the large cabinets. A capillary thermostat ensures independent overtemperature prevention. A bimetal thermostat is integrated in the heating element		
Temperature range	35 -60°C		
Preset temperatures	GE-2442: max temp is set to 42°C, GE-2470: max temp is set to 60°C		
Noise level	< 40dB		
Storage and transport	-20°C to + 40°C		
Type of operation	Continuous		
CE - marking	According to EU 2017/745 (MDR) and 2011/65/EU (RoHS).		
Expected lifetime	Kanmed warrants a safe lifetime of 10 years from first day of use. This is under the condition that the Cabinet has been serviced according to the user and or service manual and that the unit has not been modified or changed in any way or for any reason.		

Ordering Information					
Article /Ordering Numbers:	Large Cabinet		Small Cabinet		Combination Cabinet
	Universal	Blanket Warming	Universal	Blanket Warming	
Cabinet with adjustable feet	GE-2350L	GE-2380L	GE-2350S	GE-2380S	GE-2350D
Shelf	GE-41500	-	GE-41500	-	GE-41500
Basket	GE-41600	-	GE-41600	-	GE-41600
Shelf Blanket Cabinet	-	GE-41580	-	GE-41580	GE-41580
Wheel Kit Large Cabinet	GE-41700	GE-41700	-	-	GE-41700
Wheel Kit Small Cabinet	-	-	GE-41900	GE-41900	-
Table Top cabinet 42°C	GE-2442				
Table Top cabinet 60°C	GE-2470				
Shelf GE-2442	H49815				
Shelf perforated GE-2470	GE-41550				

Identification label: Sample Table Top Cabinet

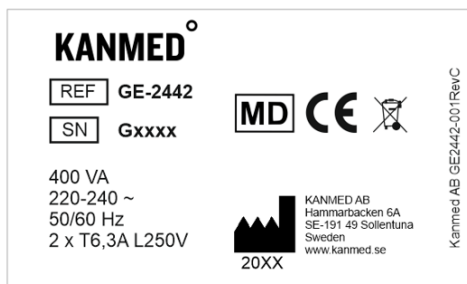

9. ACCESSORIES AND SPARE PARTS

More information can be found on www.kanmed.se

SPARE PARTS for GE-23XX cabinets

Part no	Position, see pictures		Description	Quantity
700-0180	4	S2	Mains power switch	1
700-0883	8	M1	Fan	1
700-0862	8	M1	Fan, Only for GE-2350D (2pcs per Cabinet)	1
700-0849	12	HE	Heating Element 500W, Fits all cabinets	1
700-0865			As of serial number 4740 the heating element has been replaced with heating element 500W	
700-0457	9	G1	Temperature sensor	1
700-0864	9	G1	Temperature sensor in lower compartment GE-2350D	1
700-0456	10	TR	Transformer for cabinets below serial number 4440/13 (Not valid in GE-2350D)	1
700-0886	5	T1	Replaces 700-0821. Temperature regulator Valid for cabinets with serial number below 4440/13 on large cabinets and 4479/13 for small cabinets.	1
700-0885	5	T1	Temperature regulator (GE-2350D 230Vac 2pcs per Cabinet) replaces the 700-0863.	1
700-0458	6	T2	Thermostat, Same on all Cabinets,	1
700-0187	7	L1	Red lamp	1
700-0202			Glass for door to Cabinet 175 cm high	1
700-0212			Glass for door to Cabinet 90 cm high	1
700-0850			Magnetic Handle for door	1
700-0203			Wall mounting bracket	2
700-0669			Door gasket	2m
700-0206			Foot for Cabinet	1
	4		Fuse T6,3AL 250V	
	13		Fuse T50mA 250V	
	4		Fuse T10AL 250V Cabinet 2350D	
GE-E4055			Pair of rails for Cabinets with serial number 4xxx up to 4070	1
700-0895	14	SSR	SSR, Solid state relay with zero crossing	1
Parts for the Table top Cabinet				
Regulator T1 and T2 Thermostat are same for all cabinets				
700-0887			Fan	
700-0888			Heating Element	
700-0889			Door handle	
700-0890			Door, complete incl opening handle with 2 keys.	
700-0891			Door gasket	
700-0892			Rubber feet	
700-0893			Set of keys. NOTE: all keys are identical.	
700-0895	14	SSR	SSR, Solid state relay relay with zero crossing	1

Note: Parts and their location may vary depending of type of Cabinet.

REGULATOR COMPARTMENT

Now accessible from the top by removing the 4 corner screws. Note That the GE-2350D combination cabinet has a double circuit arrangement.

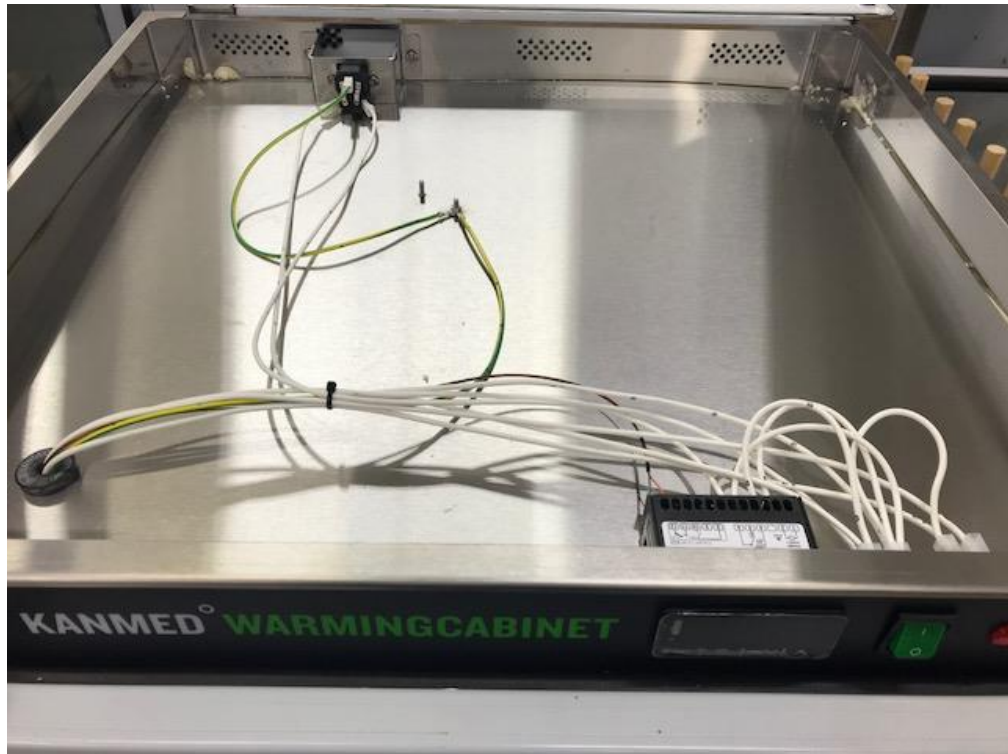

FAN AND HEATING ELEMENT COMPARTMENT GE-23XXX

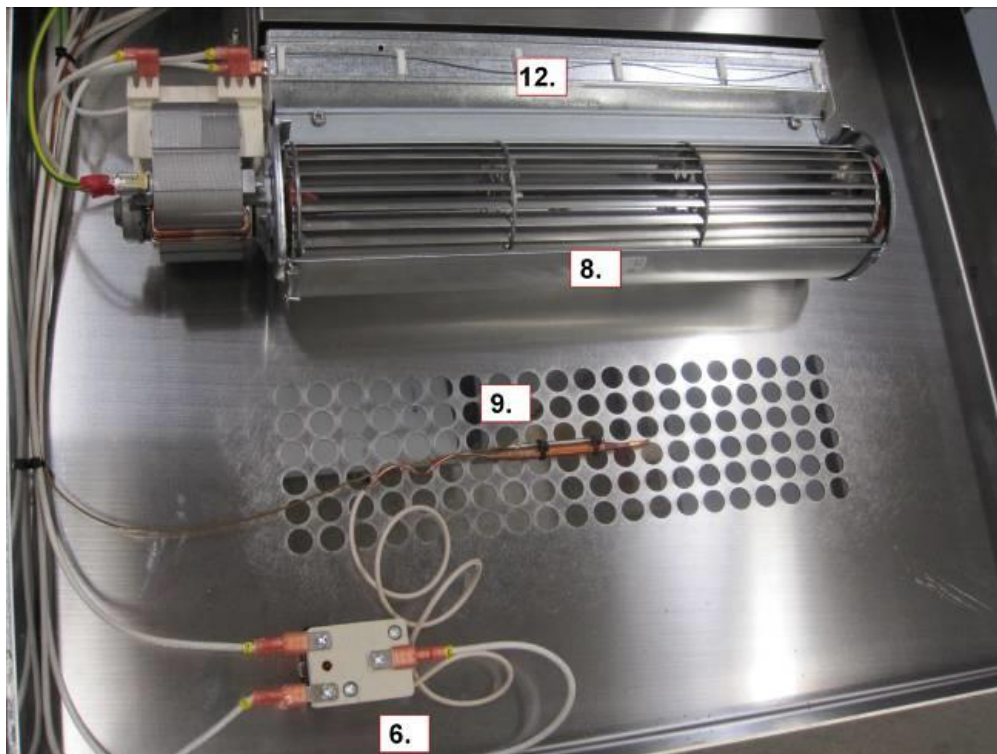

REGULATOR COMPARTMENT.

Old cabinets that has a 12V transformer to power the regulator.

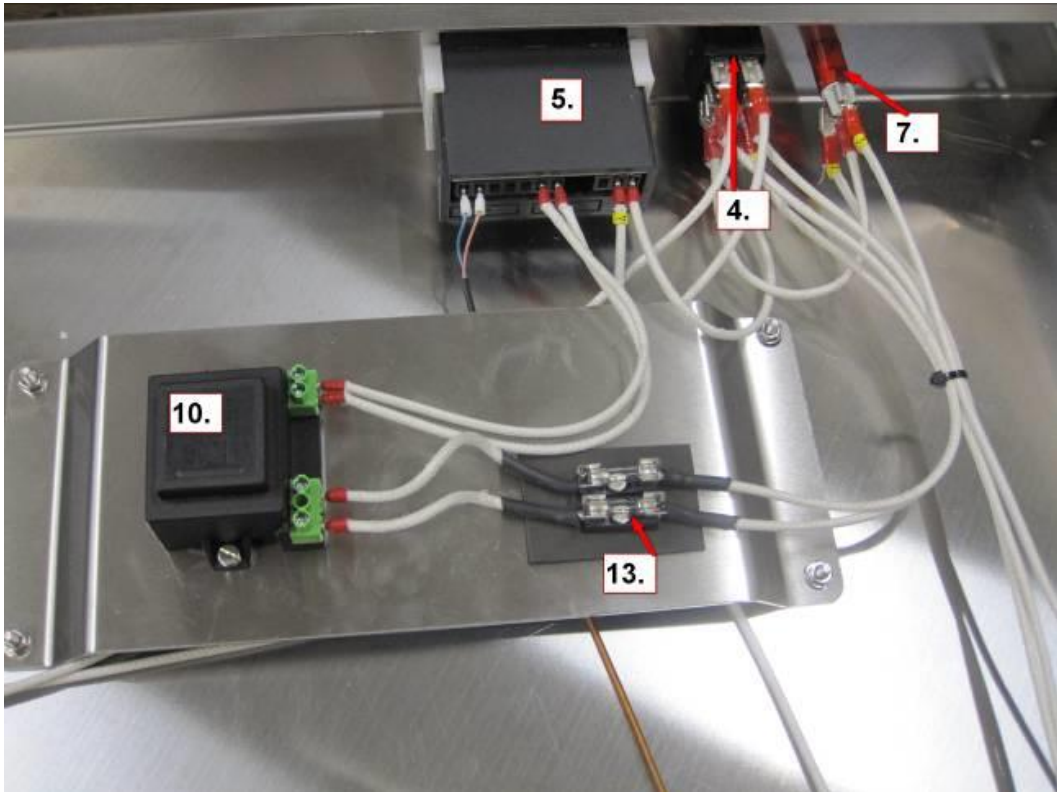

LAYOUT TABLE TOP CABINET.

Note that all parts are accessible by removing the top lid.



10. CIRCUIT DIAGRAM for Cabinets with Art. no. GE-2xxx

DIAGRAM 1

For all new GE-2xxx Cabinets with new regulator 700-0885, 230Vac and installed Solid state relay.
Valid from April 2022

The upper part of the diagram below is valid for all single compartment cabinets including the desk top cabinet.

The whole the drawing apply only to the dual cabinet version (GE-2350D).
(Observe that the power intake and K1, load, have changed position compared to older regulator versions.)

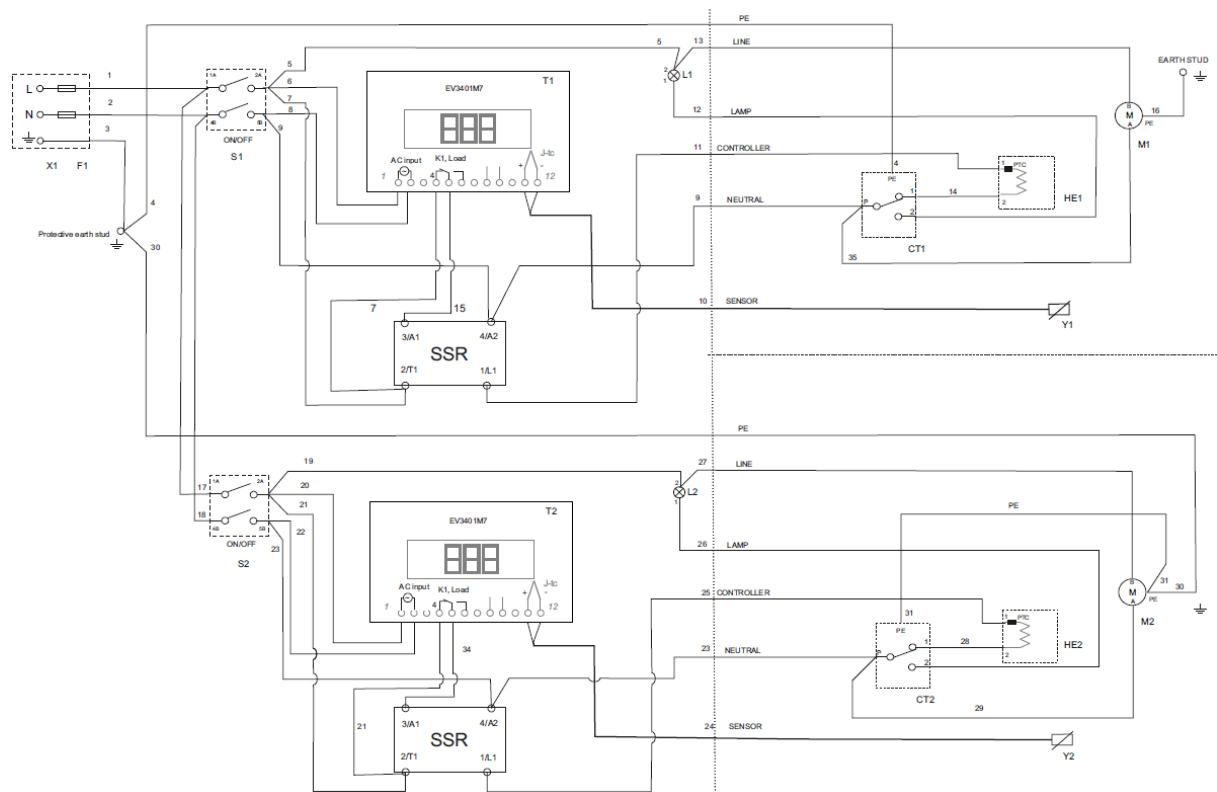

DIAGRAM 2

Older GE-2350D Combination Cabinet

Valid for Cabinets with old Temperature regulator: 700-0863

(Observe that if you replace the temperature regulator to new model 700-0885 the power intake and K1, load, have changed position)

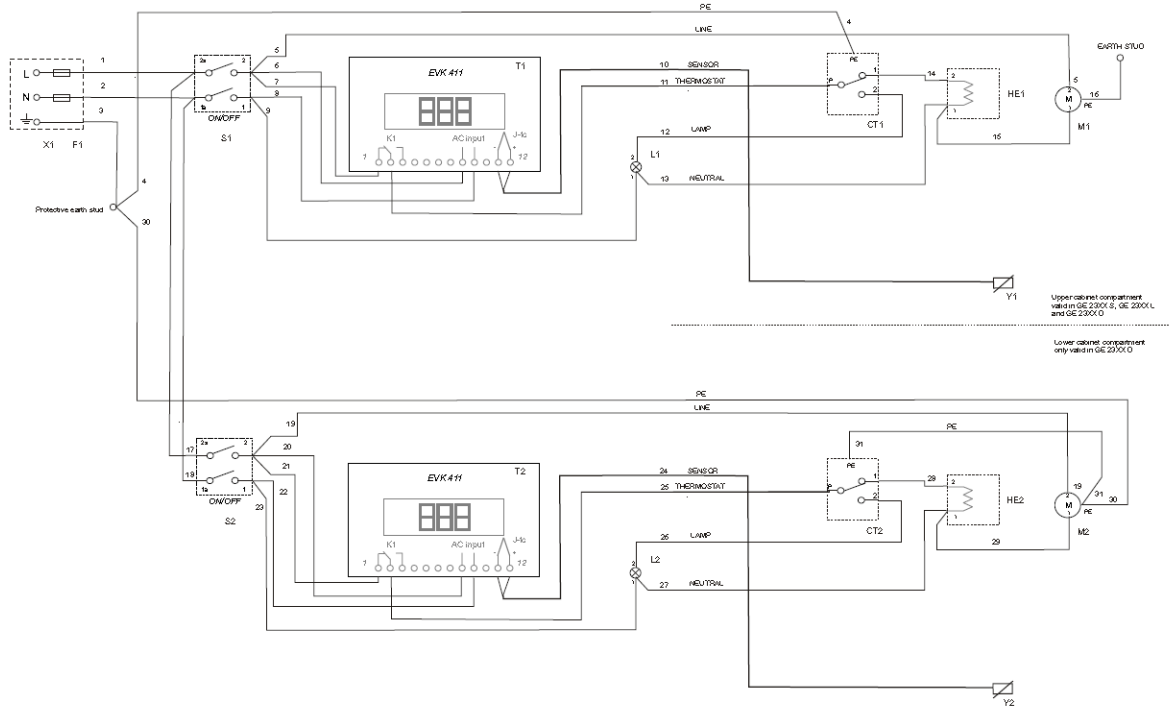
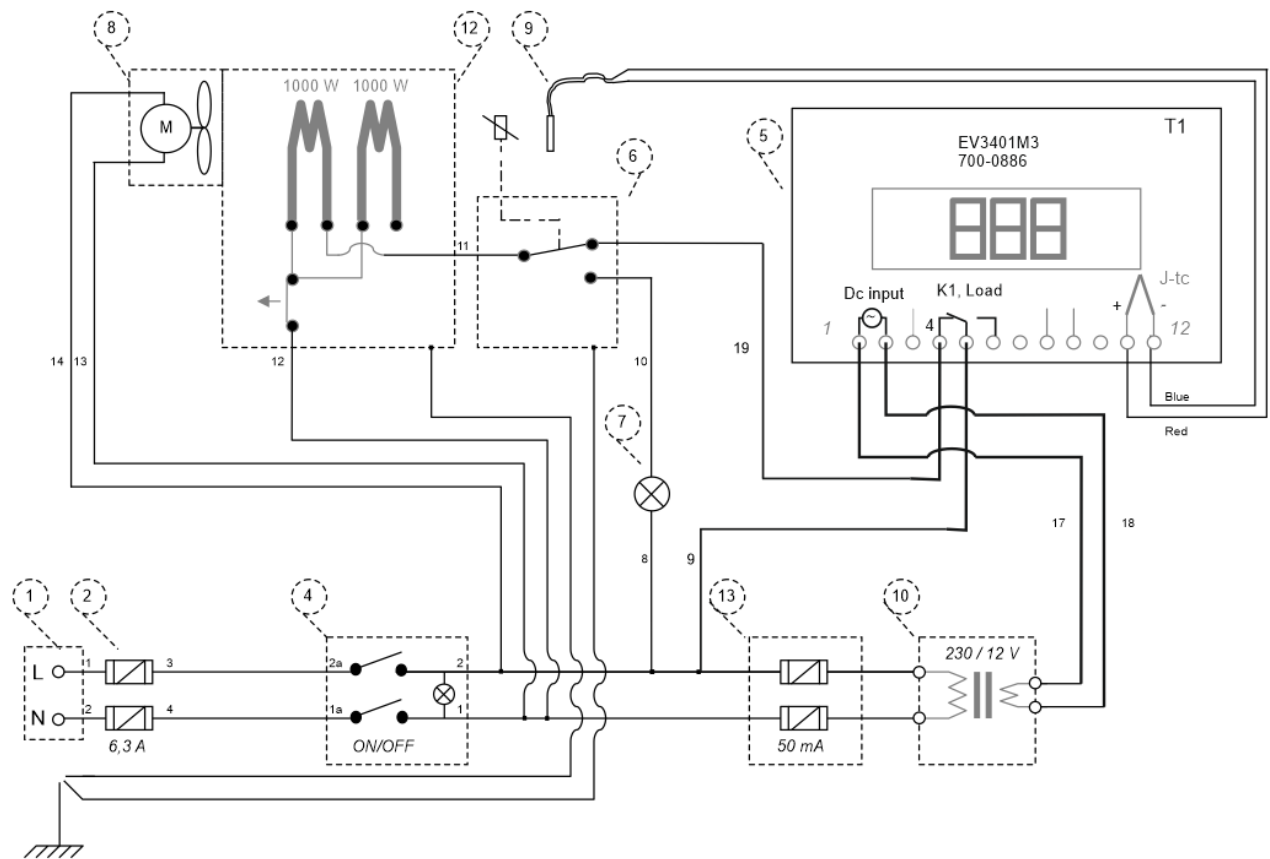

DIAGRAM 3

Older cabinets with transformer for the temperature regulator.

For old cabinets that has a transformer and where you need to replace the old temperature regulator 700-0821 with the new 700-0886, both powered by 12 Vdc transformer.

If you repair an older cabinet and update to the new 700-0886 regulator you must observe the new power intake position from the transformer, as shown in the diagram below.



11. WARRANTY

Kanmed warrants the purchaser that the Warming Cabinet is free from defects in material and workmanship for a period of 24 month from the date of delivery unless otherwise agreed in writing. The sole obligation of Kanmed with respect to any such defect is limited to the repair with new or re-manufactured parts or, at the discretion of Kanmed, replacement of the equipment or refunding of the purchase price.

This warranty shall not apply if the product has been modified, adjusted or repaired other than by Kanmed or by organisations authorised by Kanmed or modified, adjusted or repaired not in accordance with written instructions provided by Kanmed or if the equipment has been subject to misuse, negligence or accident.

These warranties are made on the condition that prompt notification of a defect is given to Kanmed or its authorised dealers within the warranty period.

Kanmed shall have the sole right to determine whether a defect exists.

Kanmed shall not in any case be liable for special or consequential damages arising from the breach of warranty, breach of contract, negligence, or any other legal theory.

12. EMC COMPATIBILITY STATEMENT

The Warming Cabinets shall be used in a hospital environment, but not close to HF surgical equipment or MR cameras.

WARNING: Use of accessories and cables other than those specified or provided by the manufacturer of this equipment could result in increased electromagnetic emissions or decreased electromagnetic immunity of this equipment and result in improper operation.

WARNING: Portable RF communications equipment (e.g. mobile phones, radio transmitters, antenna cables and external antennas) should be used no closer than 30 cm (12 inches) to any part of the Warming Cabinet, including cables specified by the manufacturer. Otherwise, degradation of the performance of this equipment could result.

NOTE: The EMISSIONS characteristics of this equipment make it suitable for use in industrial areas and hospitals (CISPR 11 class A). If it is used in a residential environment (for which CISPR 11 class B is normally required) this equipment might not offer adequate protection to radio-frequency communication services. The user might need to take mitigation measures, such as relocating or re-orienting the equipment.

For further information about EMC compliance with the specified emissions and immunity standard, test levels, etc. please contact Kanmed.

13. END OF LIFE



When the product has reached end of life, it should be recycled in accordance with the 2012/19/EU (WEEE) directive if applicable.

Double Cabinet GE-2380D

Note that on this cabinet the doors are right



Universal warming Cabinet GE-2350 equipped with 8 shelves and 2 drawers.
Note: The door is hung on the left side which is standard.



KANMED° **WARMINGCABINET**

KANMED°
a MedCare Visions® company

Hammarbacken 6A
SE-191 49 Sollentuna
SWEDEN

Tel +46 (0)8 564 80 630

E-Mail: info@kanmed.se
E-mail: order@kanmed.se
Home page: www.kanmed.se

DISTRIBUTED BY: